

KW50Z Door Details

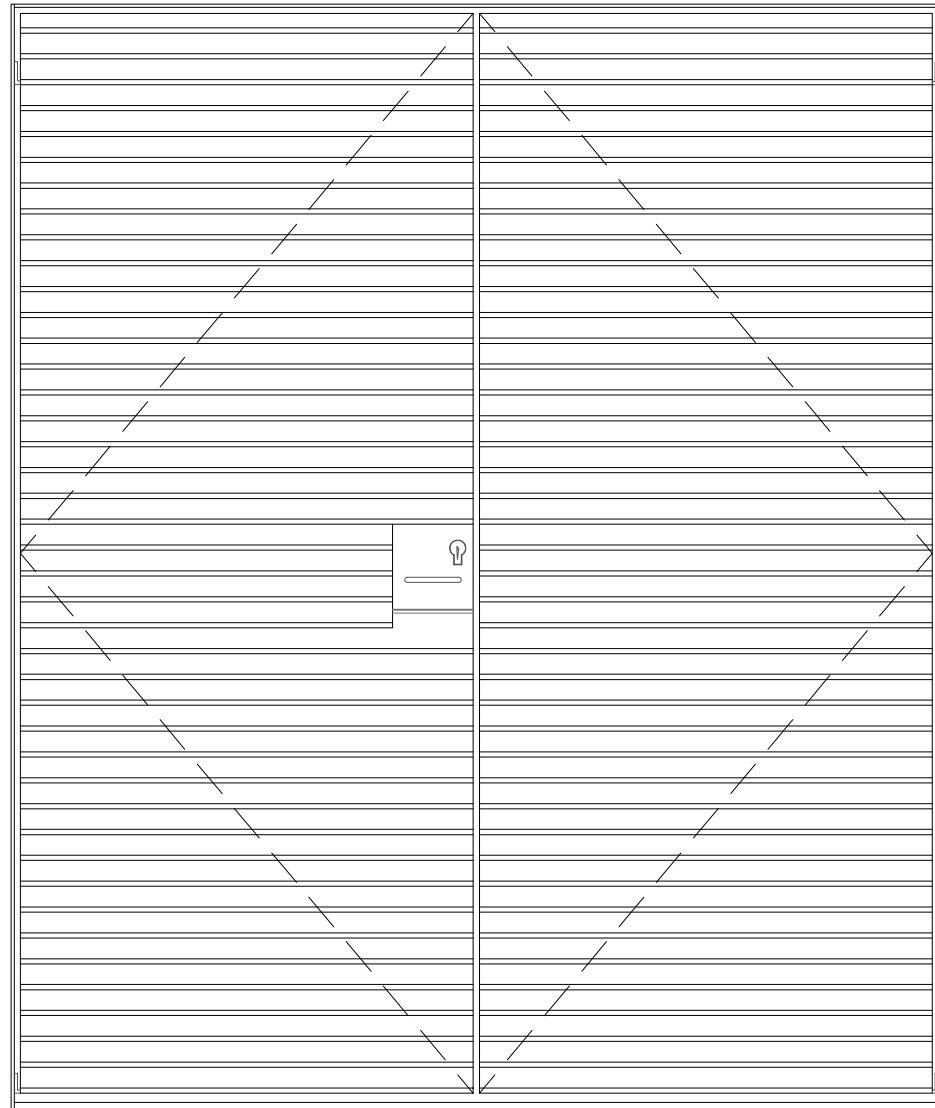

Double Door
Front Elevation

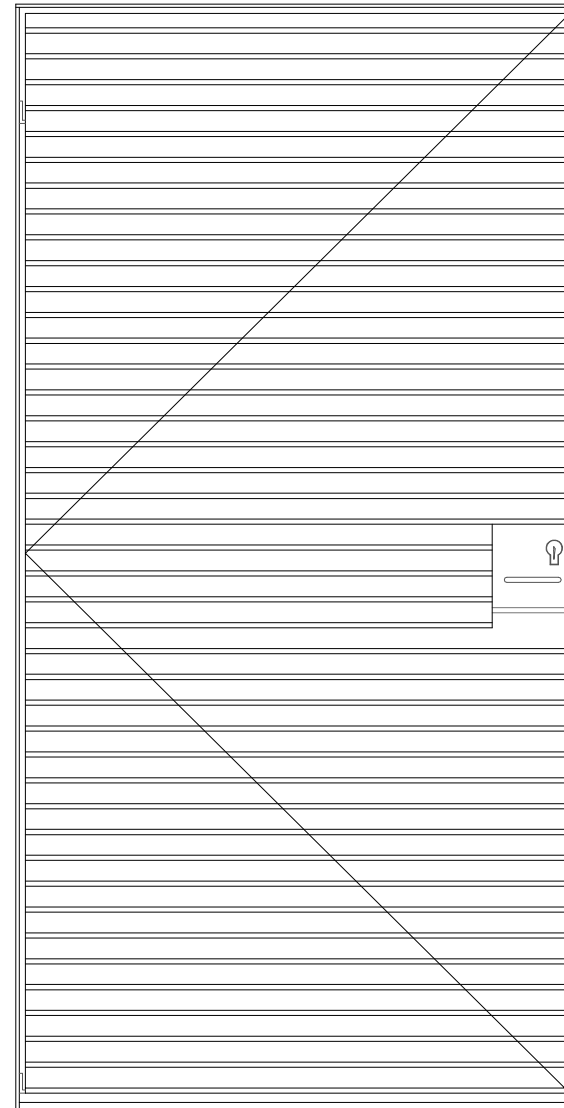

Single Door
Front Elevation

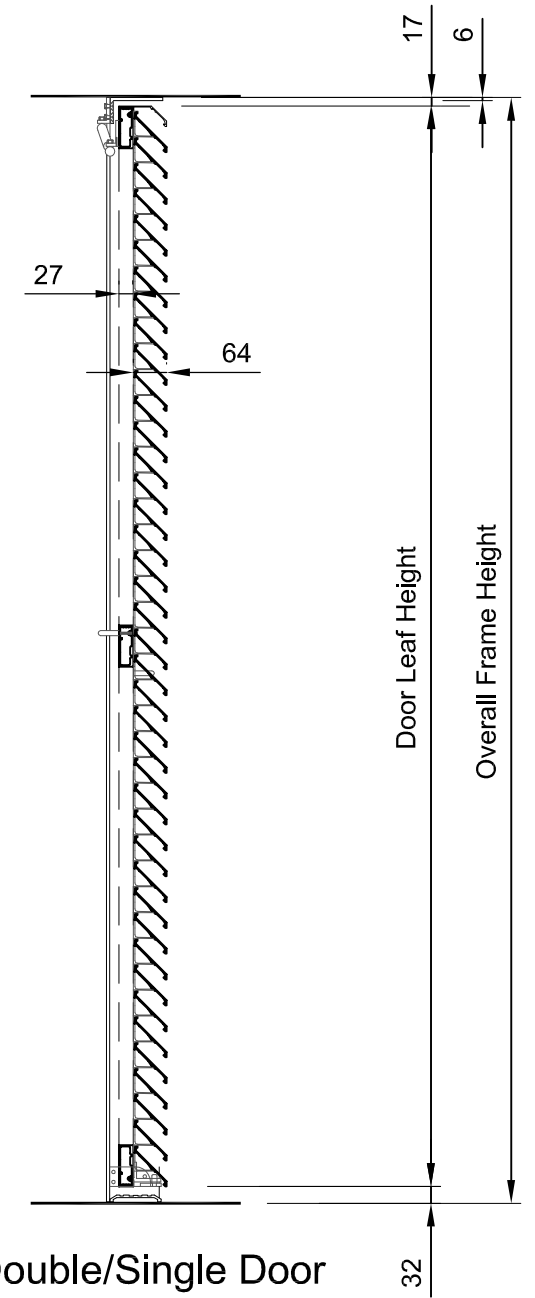

Double/Single Door
Vertical Section

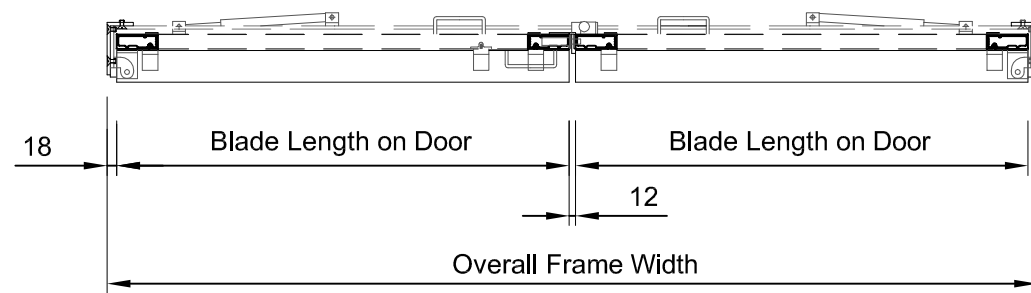

Double Door
Horizontal Section

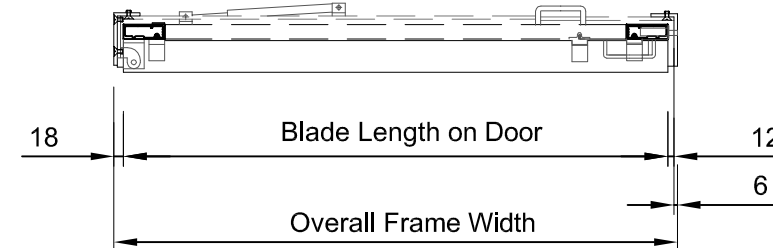

Single Door
Horizontal Section

SPS Louvre Systems Limited



30 The Roystons
Willowhayne Estate, East Preston
West Sussex. BN16 2TR
01903 770179
contracts@spslouvresystems.co.uk
www.spslouvresystems.com

KW50Z M1 Framed/Flanged Details

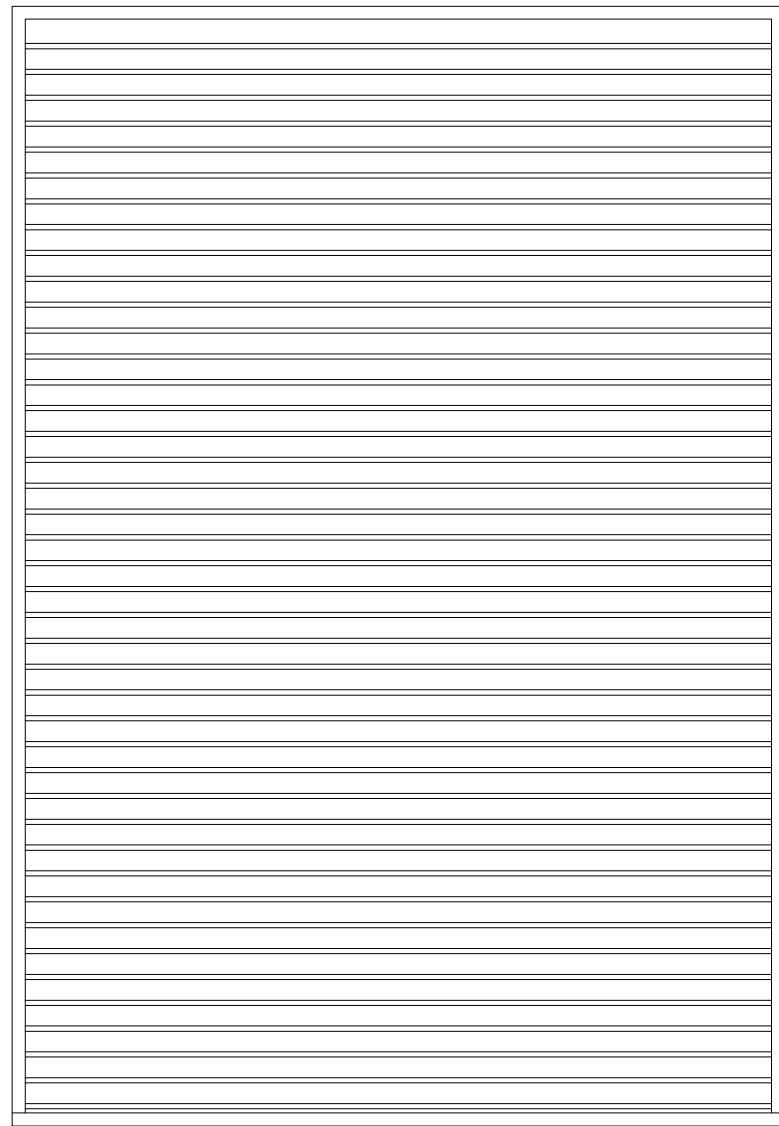

Framed Assembly
Front Elevation

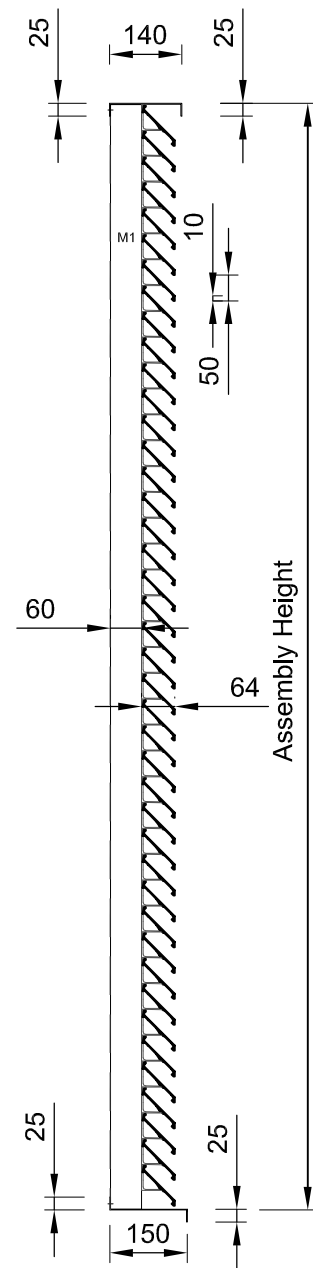

Framed Assembly
Vertical Section

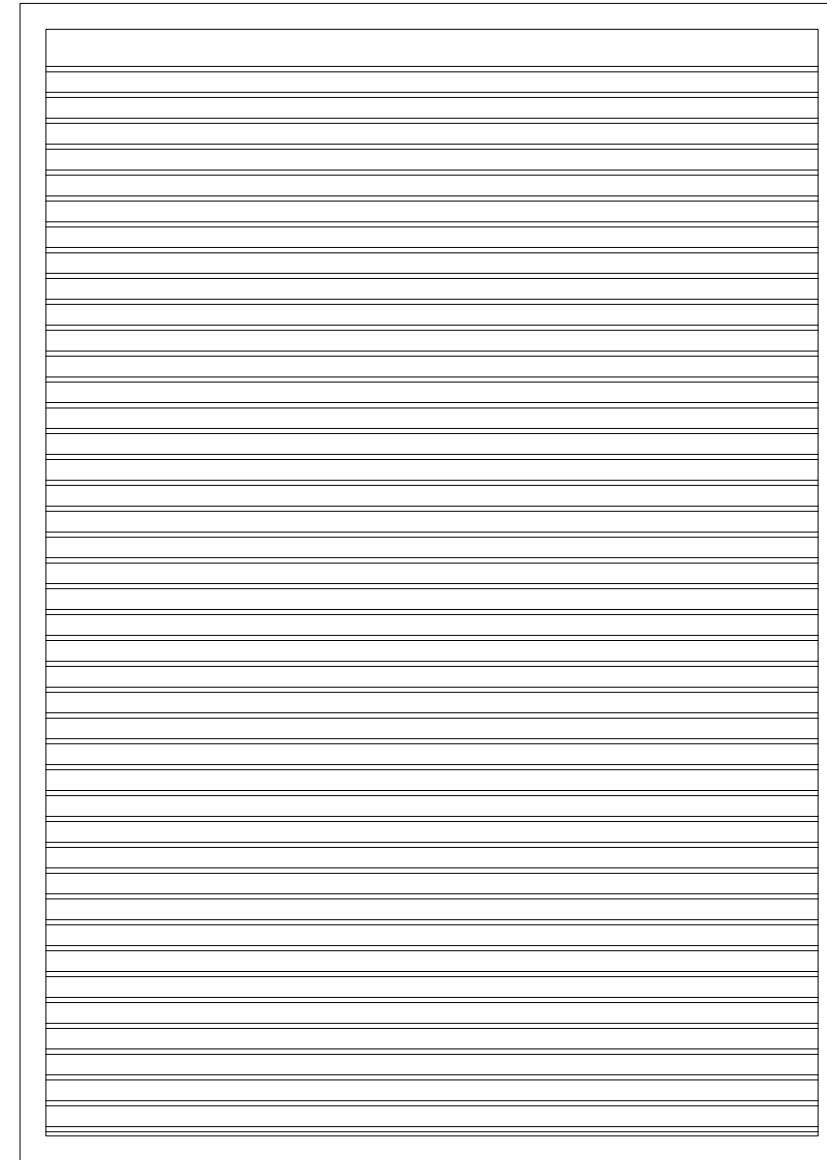

Flanged Assembly
Front Elevation

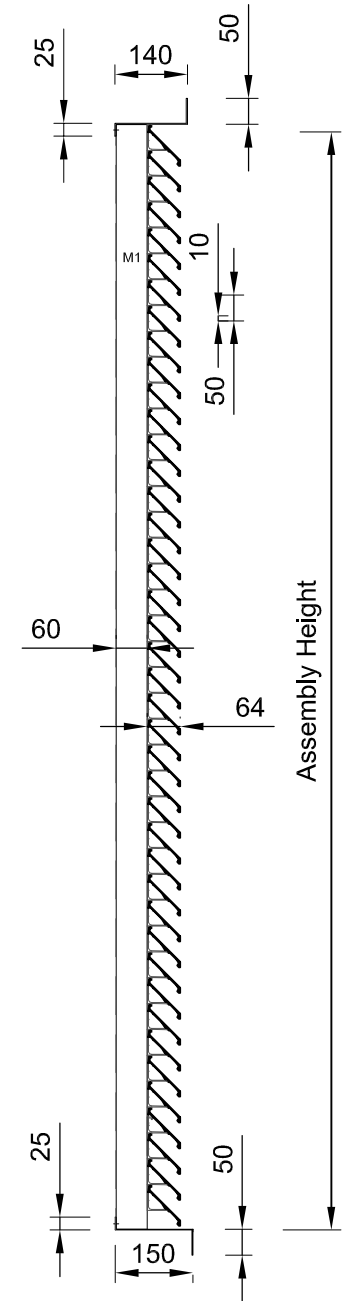

Flanged Assembly
Vertical Section

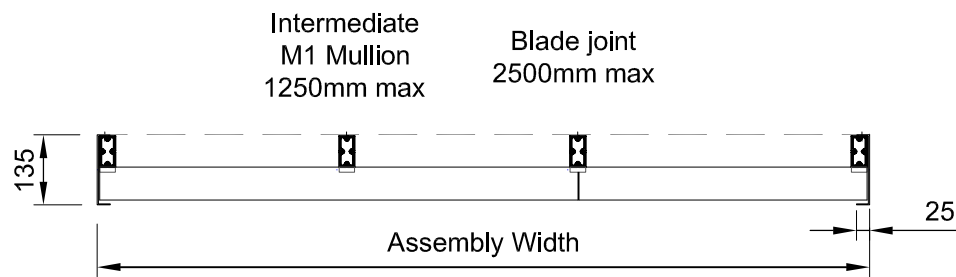

Framed Assembly
Horizontal Section

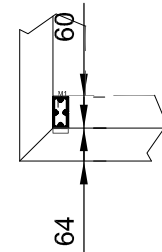

Mitred Corner
Horizontal Section

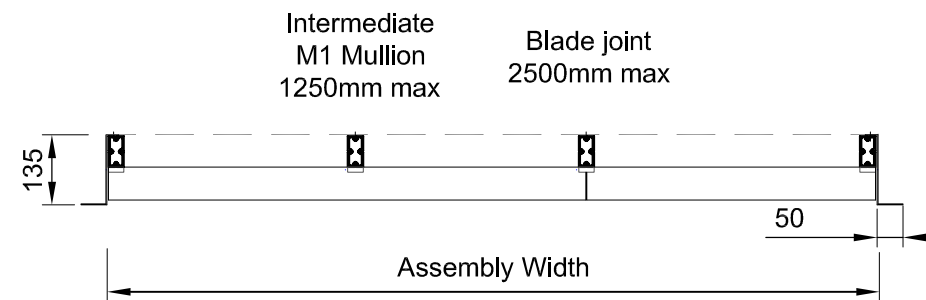

Flanged Assembly
Horizontal Section

SPS Louvre Systems Limited



30 The Roystons
Willowhayne Estate, East Preston
West Sussex. BN16 2TR
01903 770179
contracts@spslouvre systems.co.uk
www.spslouvre systems.com

KW50Z M1A Framed/Flanged Details

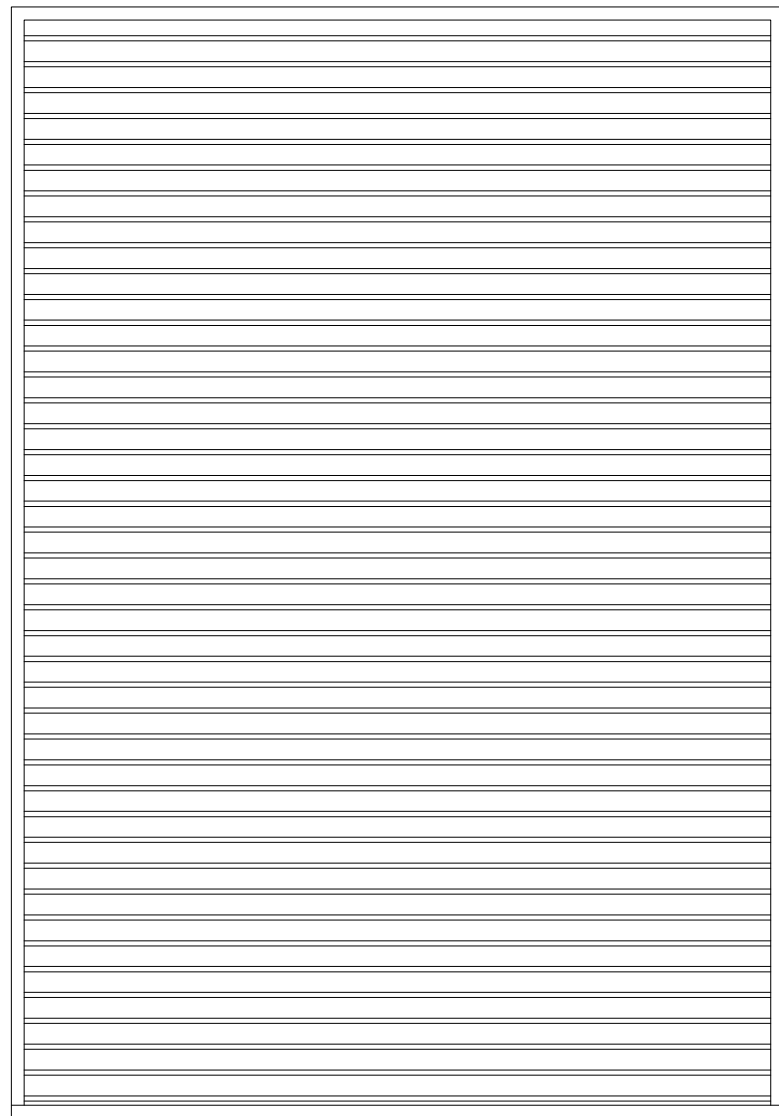

Framed Assembly
Front Elevation

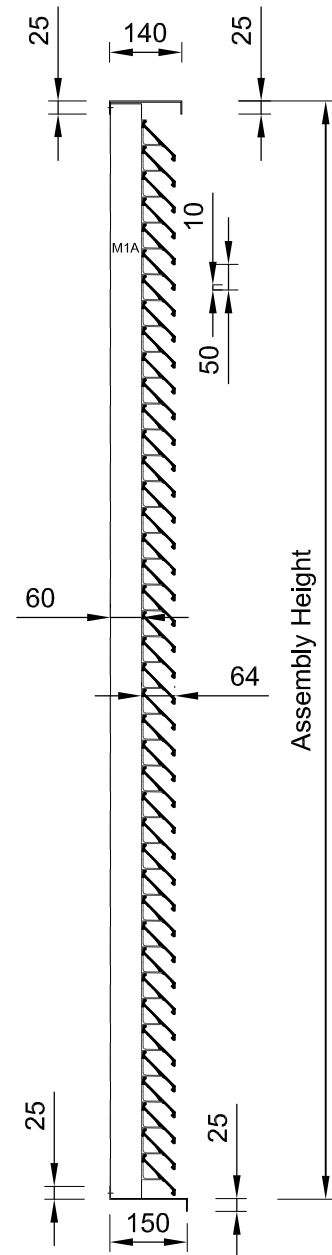

Framed Assembly
Vertical Section



Flanged Assembly
Front Elevation

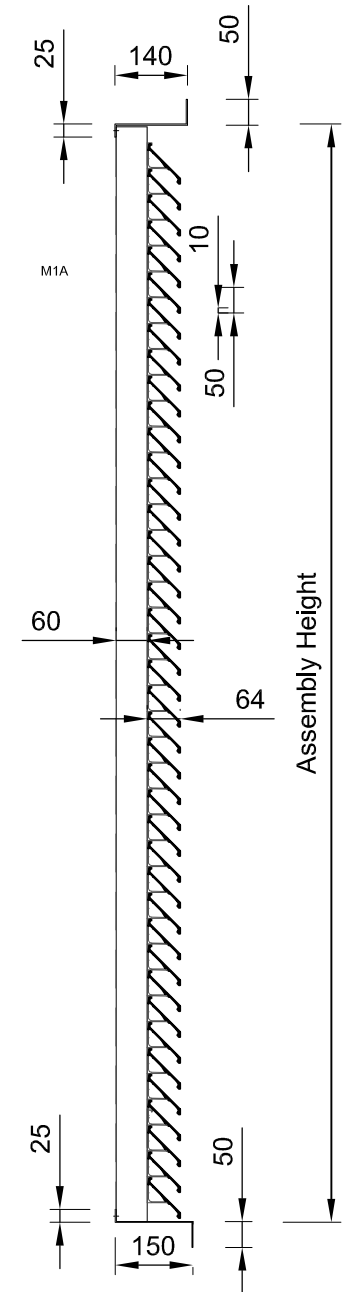

Flanged Assembly
Vertical Section

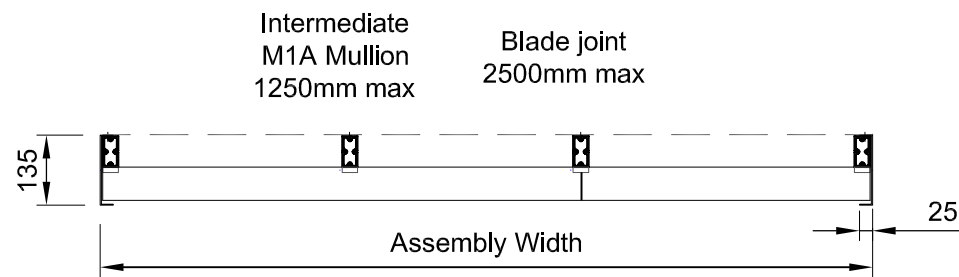

Framed Assembly
Horizontal Section

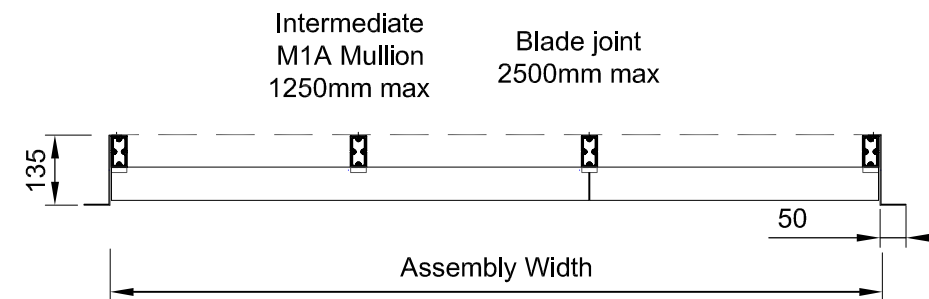

Flanged Assembly
Horizontal Section

SPS Louvre Systems Limited



30 The Roystons
Willowhayne Estate, East Preston
West Sussex. BN16 2TR
01903 770179
contracts@spslouvresystems.co.uk
www.spslouvresystems.com

KW50Z M2 Framed/Flanged Details

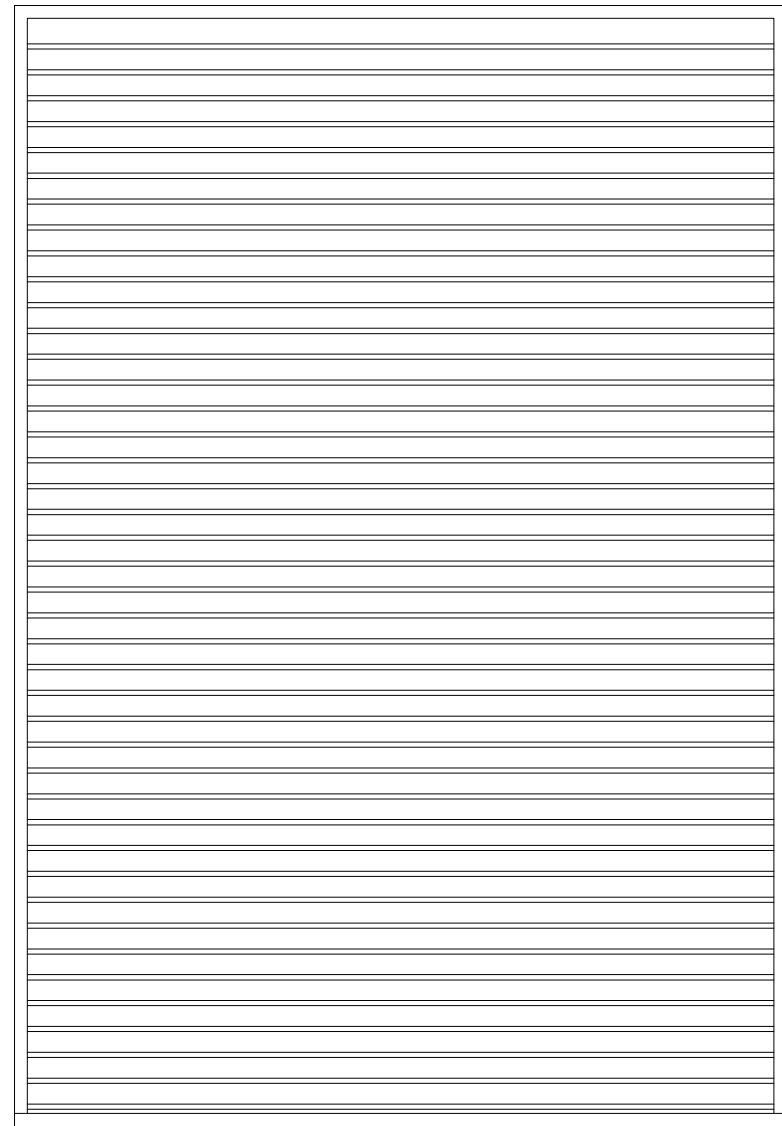

Framed Assembly
Front Elevation

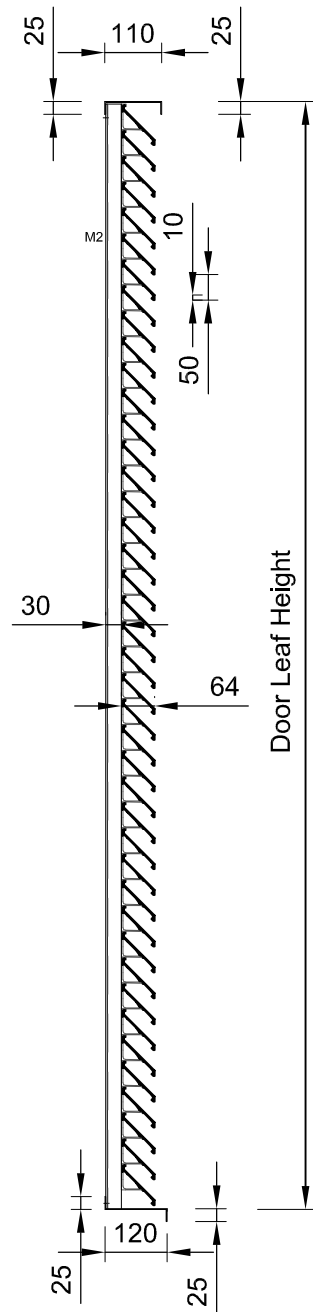

Framed Assembly
Vertical Section



Flanged Assembly
Front Elevation

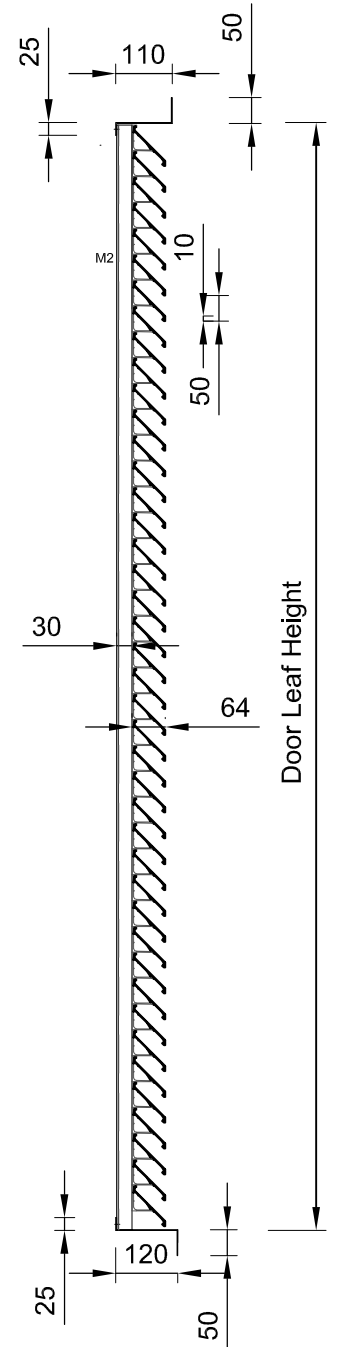

Flanged Assembly
Vertical Section

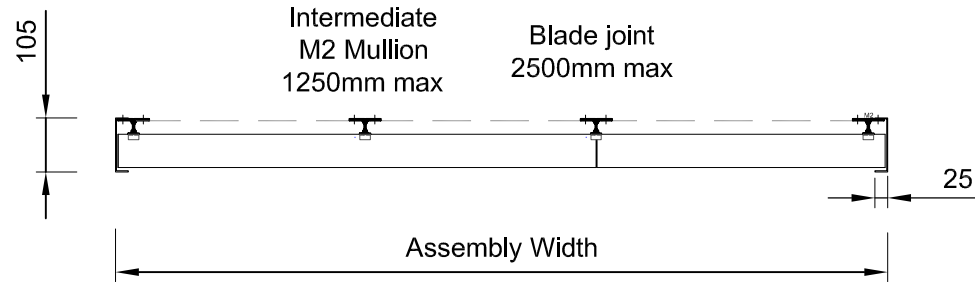

Framed Assembly
Horizontal Section

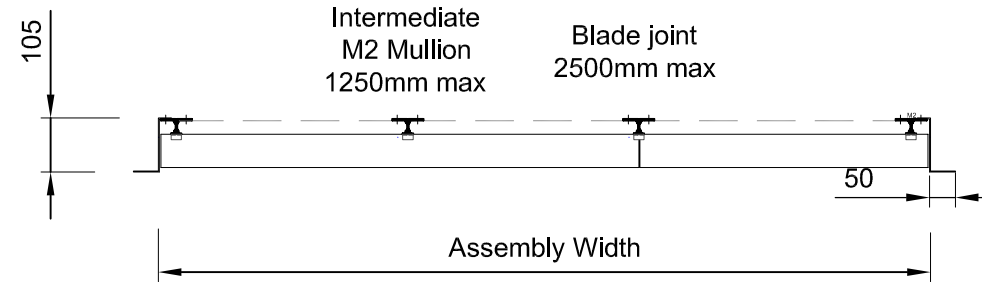

Flanged Assembly
Horizontal Section

SPS Louvre Systems Limited



30 The Roystons
Willowhayne Estate, East Preston
West Sussex. BN16 2TR
01903 770179
contracts@spslouvresystems.co.uk
www.spslouvresystems.com

KW50Z M3 Framed/Flanged Details

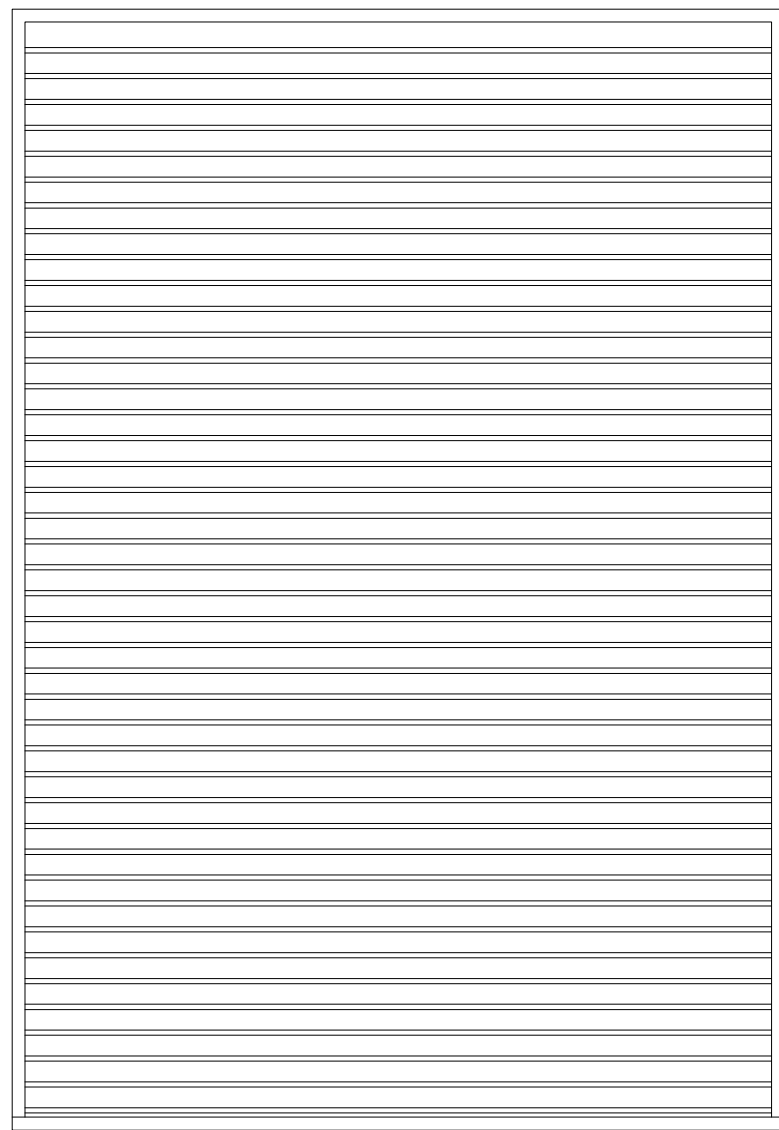

Framed Assembly
Front Elevation

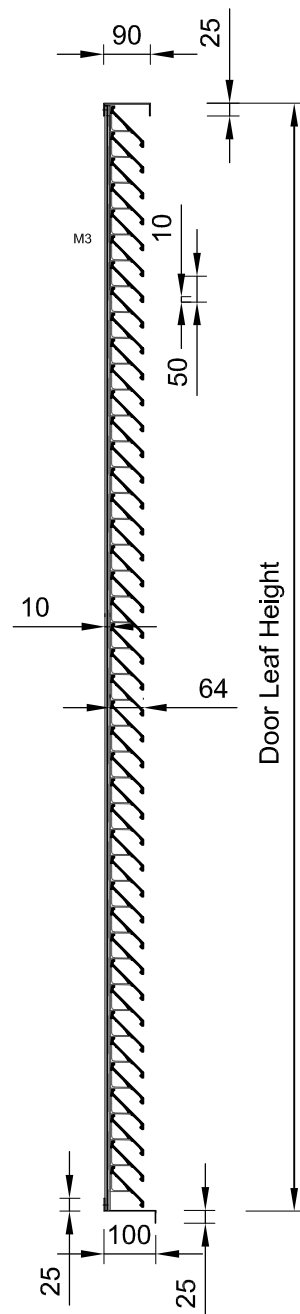

Framed Assembly
Vertical Section

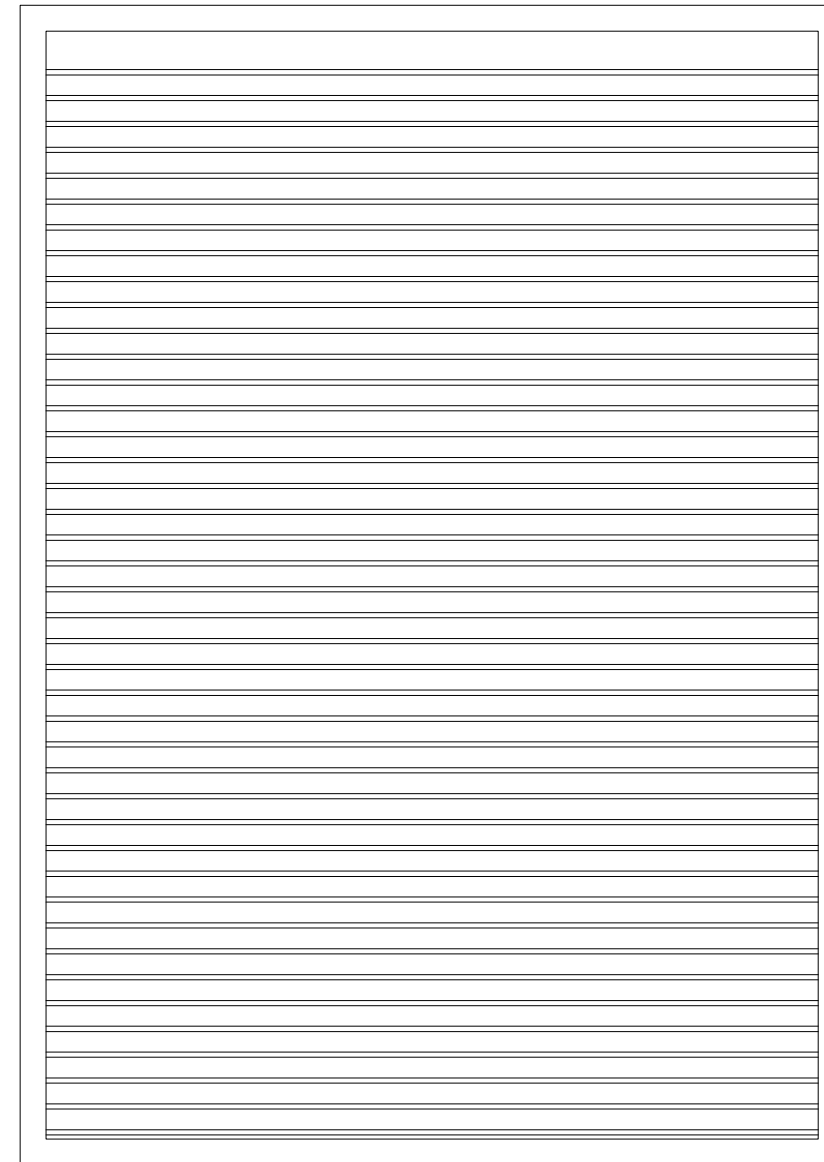

Flanged Assembly
Front Elevation

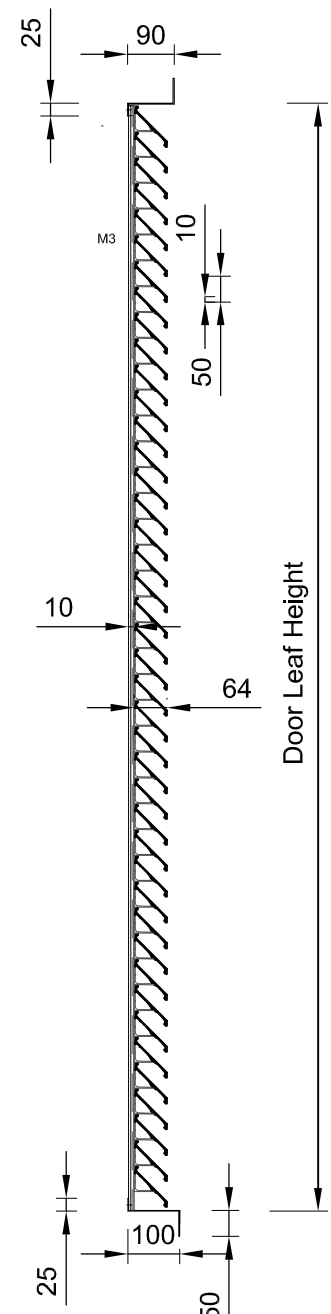

Flanged Assembly
Vertical Section

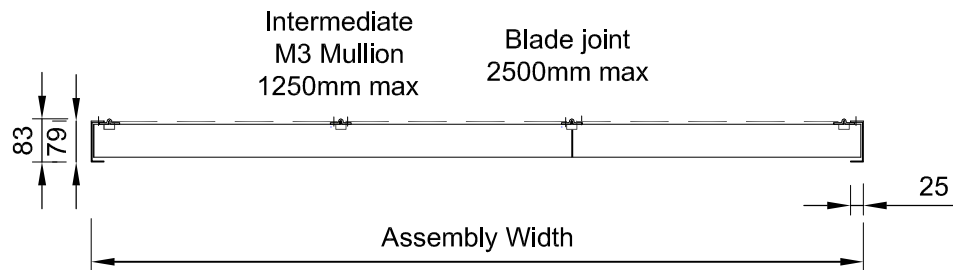

Framed Assembly
Horizontal Section

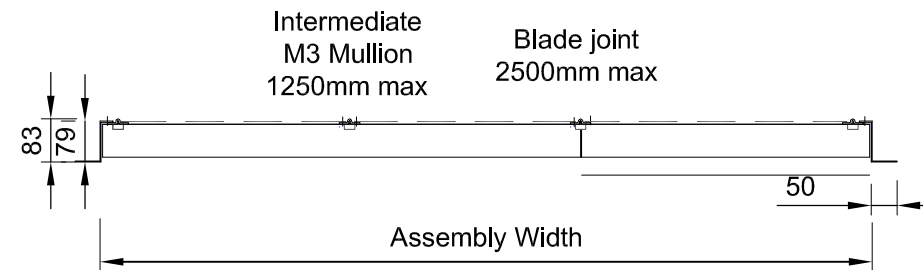

Flanged Assembly
Horizontal Section

SPS Louvre Systems Limited



30 The Roystons
Willowhayne Estate, East Preston
West Sussex. BN16 2TR
01903 770179
contracts@spslouvresystems.co.uk
www.spslouvresystems.com